

## IMPORTANT SAFETY INSTRUCTIONS

### Notice to Installers

The servicing instructions in this notice are for use by qualified service personnel only. To reduce the risk of electric shock, do not perform any servicing other than that contained in the operating instructions, unless you are qualified to do so.

**Note to System Installer**  
For this apparatus, the coaxial cable shield/screen shall be grounded as close as practical to the point of entry of the cable into the building. For products sold in the US and Canada, this reminder is provided to call the system installer's attention to Article 820-93 and Article 820-100 of the NEC (or Canadian Electrical Code Part 1), which provides guidelines for proper grounding of the coaxial cable shield.



This symbol is intended to alert you that uninsulated voltage within this product may have sufficient magnitude to cause electric shock. Therefore, it is dangerous to make any kind of contact with any inside part of this product.

Ce symbole a pour but d'alerter toute personne qu'un contact avec une pièce interne de ce produit, sous tension et non isolée, pourrait être suffisant pour provoquer un choc électrique. Il est donc dangereux d'être en contact avec toute pièce interne de ce produit.



**CAUTION**  
RISK OF ELECTRIC SHOCK  
DO NOT OPEN



**AVIS**  
RISQUE DE CHOC ÉLECTRIQUE  
NE PAS OUVRI

CAUTION: To reduce the risk of electric shock, do not remove cover (or back). No user-serviceable parts inside. Refer servicing to qualified service personnel.

**WARNING**  
TO PREVENT FIRE OR ELECTRIC SHOCK, DO NOT EXPOSE THIS UNIT TO RAIN OR MOISTURE.



This symbol is intended to alert you of the presence of important operating and maintenance (servicing) instructions in the literature accompanying this product.

Ce symbole a pour but de vous avertir qu'une documentation importante sur le fonctionnement et l'entretien accompagne ce produit.

20080814\_Installer820



# Cisco HD Digital Transport Adapter (DTA)



**Note:** This illustration may vary from the actual product.

- 1) Read these instructions.
- 2) Keep these instructions.
- 3) Heed all warnings.
- 4) Follow all instructions.
- 5) Do not use this apparatus near water.
- 6) Clean only with dry cloth.
- 7) Do not block any ventilation openings. Install in accordance with the manufacturer's instructions.
- 8) Do not install near any heat sources such as radiators, heat registers, stoves, or other apparatus (including amplifiers) that produce heat.
- 9) Do not defeat the safety purpose of the polarized or grounding-type plug. A polarized plug has two blades with one wider than the other. A grounding-type plug has two blades and a third grounding prong. The wide blade or the third prong are provided for your safety. If the provided plug does not fit into your outlet, consult an electrician for replacement of the obsolete outlet.
- 10) Protect the power cord from being walked on or pinched particularly at plugs, convenience receptacles, and the point where they exit from the apparatus.
- 11) Only use attachments/accessories specified by the manufacturer.
- 12)  Use only with the cart, stand, tripod, bracket, or table specified by the manufacturer, or sold with the apparatus. When a cart is used, use caution when moving the cart/apparatus combination to avoid injury from tip-over.
- 13) Unplug this apparatus during lightning storms or when unused for long periods of time.
- 14) Refer all servicing to qualified service personnel. Servicing is required when the apparatus has been damaged in any way, such as a power-supply cord or plug is damaged, liquid has been spilled or objects have fallen into the apparatus, the apparatus has been exposed to rain or moisture, does not operate normally, or has been dropped.

### Power Source Warning

A label on this product indicates the correct power source for this product. Operate this product only from an electrical outlet with the voltage and frequency indicated on the product label. If you are uncertain of the type of power supply to your home or business, consult your service provider or your local power company.

The AC inlet on the unit must remain accessible and operable at all times.

### Ground the Product

 **WARNING: Avoid electric shock and fire hazard! If this product connects to coaxial cable wiring, be sure the cable system is grounded (earthed). Grounding provides some protection against voltage surges and built-up static charges.**

 **WARNING: Avoid electric shock and fire hazard! Do not locate an outside antenna system in the vicinity of overhead power lines or power circuits. Touching power lines or circuits might be fatal.**

This product may contain a tuner capable of receiving off-the-air broadcasts.

### Protect the Product from Lightning

In addition to disconnecting the AC power from the wall outlet, disconnect the signal inputs.

### Verify the Power Source from the On/Off Power Light

When the on/off power light is not illuminated, the apparatus may still be connected to the power source. The light may go out when the apparatus is turned off, regardless of whether it is still plugged into an AC power source.

### Eliminate AC Power/Mains Overloads

 **WARNING: Avoid electric shock and fire hazard! Do not overload AC power/mains, outlets, extension cords, or integral convenience receptacles. For products that require battery power or other power sources to operate them, refer to the operating instructions for those products.**

### Handling Disposable Batteries

This product may contain disposable batteries. Heed the following warning and follow the Battery Safety and Battery Disposal instructions below.

 **WARNING: There is danger of explosion if the battery is mishandled or incorrectly replaced. Replace only with the same type of battery. Do not disassemble it or attempt to recharge it outside the system. Do not crush, puncture, dispose of in fire, short the external contacts, or expose to water or other liquids. Dispose of the battery in accordance with local regulations and instructions from your service provider.**

### Battery Safety

- Insert batteries correctly. There may be a risk of explosion if the batteries are incorrectly inserted.
- Do not attempt to recharge 'disposable' or 'non-reusable' batteries.
- Please follow instructions provided for charging 'rechargeable' batteries.
- Replace batteries with the same or equivalent type that we recommend.
- Do not expose batteries to excessive heat (such as sunlight or fire).
- Do not expose batteries to temperatures above 100°C (212°F).

### Battery Disposal

- The batteries may contain substances that could be harmful to the environment.
- Recycle or dispose of batteries in accordance with the battery manufacturer's instructions and local/national disposal and recycling regulations.



- The batteries may contain perchlorate, a known hazardous substance, so special handling and disposal of this product might be necessary. For more information about perchlorate and best management practices for perchlorate-containing substance, see [www.dtsc.ca.gov/hazardouswaste/perchlorate](http://www.dtsc.ca.gov/hazardouswaste/perchlorate)

### Provide Ventilation and Select a Location

- Remove all packaging material before applying power to the product.
- Do not place this apparatus on a bed, sofa, rug, or similar surface.
- Do not place this apparatus on an unstable surface.
- Do not install this apparatus in an enclosure, such as a bookcase or rack, unless the installation provides proper ventilation.
- Do not place entertainment devices (such as VCRs or DVDs), lamps, books, vases with liquids, or other objects on top of this product.
- Do not block ventilation openings.

### Operating Environment

This product is designed for operation indoors with a temperature range from 32° to 104° F (0° to 40° C). Each product should have adequate spacing on all sides so that the cooling air vents on the chassis are not blocked. (Protect from Exposure to Moisture and Foreign Objects)

### Protect from Exposure to Moisture and Foreign Objects

 **WARNING: Avoid electric shock and fire hazard! Do not expose this product to dripping or splashing liquids, rain, or moisture. Objects filled with liquids, such as vases, should not be placed on this apparatus.**

 **WARNING: Avoid electric shock and fire hazard! Unplug this product before cleaning. Do not use a liquid cleaner or an aerosol cleaner. Do not use a magnetic/static cleaning device (dust remover) to clean this product.**

 **WARNING: Avoid electric shock and fire hazard! Never push objects through the openings in this product. Foreign objects can cause electrical shorts that can result in electric shock or fire.**

### Service Warnings

 **WARNING: Avoid electric shock! Do not open the cover of this product. Opening or removing the cover may expose you to dangerous voltages. If you open the cover, your warranty will be void. This product contains no user-serviceable parts.**

### Check Product Safety

Upon completion of any service or repairs to this product, the service technician must perform safety checks to determine that this product is in proper operating condition.

### Protect the Product When Moving It

Always disconnect the power source when moving the apparatus or connecting or disconnecting cables.

20110316\_Cable\_Safety

### Open Source GNU GPL Statement

Cisco HD Digital Transport Adapter (DTA) contain(s), in part, certain free/open source software ("Free Software") under licenses which generally make the source code available for free copy, modification, and redistribution. Examples of such licenses include all the licenses sponsored by the Free Software Foundation (e.g. GNU General Public License (GPL), GNU Lesser General Public License (LGPL), Berkeley Software Distribution (BSD), the MIT licenses and different versions of the Mozilla and Apache licenses). To find additional information regarding the Free Software, including a copy of the applicable license and related information, please go to: (i) for North America [http://www.cisco.com/web/consumer/support/open\\_source.html](http://www.cisco.com/web/consumer/support/open_source.html), or (ii) for outside North America [http://www.cisco.com/web/consumer/support/open\\_source.html#international](http://www.cisco.com/web/consumer/support/open_source.html#international). Once at the site, search for the product listing and click on the related items identified. If you have any questions or problems accessing any of the links, please contact: [spvtg-external-opensource-requests@cisco.com](mailto:spvtg-external-opensource-requests@cisco.com).

### United States FCC Compliance

This device has been tested and found to comply with the limits for a Class B digital device, pursuant to part 15 of the FCC Rules. These limits are designed to provide reasonable protection against such interference in a residential installation. This equipment generates, uses, and can radiate radio frequency energy. If not installed and used in accordance with the instructions, it may cause harmful interference to radio communications. However, there is no guarantee that interference will not occur in a particular installation. If this equipment does cause harmful interference to radio or television reception, which can be determined by turning the equipment OFF and ON, the user is encouraged to try to correct the interference by one or more of the following measures:

- Reorient or relocate the receiving antenna.
- Increase the separation between the equipment and receiver.
- Connect the equipment into an outlet on a circuit different from that to which the receiver is connected.
- Consult the service provider or an experienced radio/television technician for help.

Any changes or modifications not expressly approved by Cisco Systems, Inc., could void the user's authority to operate the equipment.

The information shown in the FCC Declaration of Conformity paragraph below is a requirement of the FCC and is intended to supply you with information regarding the FCC approval of this device. *The phone numbers listed are for FCC-related questions only and not intended for questions regarding the connection or operation for this device. Please contact your service provider for any questions you may have regarding the operation or installation of this device.*

### FCC Declaration of Conformity

This device complies with Part 15 of FCC Rules. Operation is subject to the following two conditions: 1) the device may not cause harmful interference, and 2) the device must accept any interference received, including interference that may cause undesired operation.

Cisco HD Digital Transport Adapter (DTA)  
Models: 170HD and 171HD  
Manufactured by:  
Cisco Systems, Inc.  
5030 Sugarloaf Parkway  
Lawrenceville, Georgia 30044 USA

### Canada EMI Regulation

This Class B digital apparatus complies with Canadian ICES-003. Cet appareil numérique de la class B est conforme à la norme NMB-003 du Canada.

20081121 FCC Standard

### ENERGY STAR® Notice



This Cisco product has earned the ENERGY STAR.

Products that earn the ENERGY STAR reduce greenhouse gas emissions by meeting strict energy efficiency guidelines set by the U.S. Environmental Protection Agency and the U.S. Department of Energy. ENERGY STAR is a registered mark owned by the U.S. government.

Cisco and the Cisco logo are trademarks or registered trademarks of Cisco and/or its affiliates in the U.S. and other countries. To view a list of Cisco trademarks, go to this URL: [www.cisco.com/go/trademarks](http://www.cisco.com/go/trademarks). Third-party trademarks mentioned are the property of their respective owners. The use of the word partner does not imply a partnership relationship between Cisco and any other company. (1110R)

ENERGY STAR and the ENERGY STAR mark are registered trademarks of the U.S. government.

**HDMI** The terms HDMI and HDMI High-Definition Multimedia Interface, and the HDMI Logo are trademarks or registered trademarks of HDMI Licensing LLC in the United States and other countries.

Rovi is a trademark of Rovi Corporation.

Product and service availability are subject to change without notice.

© 2011-2012 Cisco and/or its affiliates. All rights reserved.

Printed in China

Last Updated: June 2013

Part Number 78-4040685-01D0

## Welcome

The Cisco® HD Digital Transport Adapter (DTA) works with traditional analog TVs and digital High Definition TVs. Decryption technology on the DTA lets both analog and digital TV owners view a variety of standard and high definition channels, including subscribed premium channels where offered. See your service provider for details. Use the instructions in this guide to install the DTA.

The consumer support website provides news and information about this product. For more information, please refer to: <http://www.cisco.com/web/consumer/support/index.html>

## Front Panel

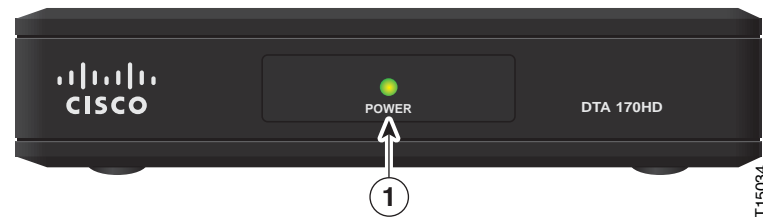

- 1 Power LED** Illuminates green when the DTA is powered up. Illuminates red when the DTA is in standby mode.

**Note:** This illustration may vary from the actual product.

### Safety and Performance Tip

Keep the top of the DTA free of all objects and electronic devices, including your TV.

## Back Panel

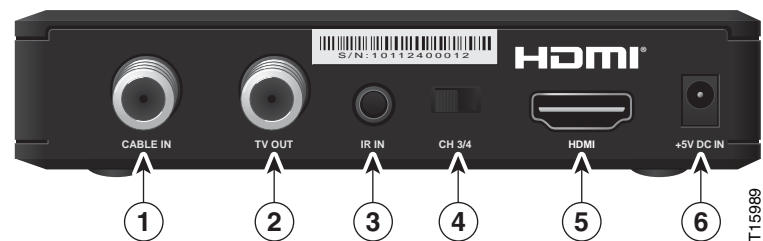

- 1 Cable In** Connects to a coaxial cable that delivers the signal from your service provider
- 2 TV Out** Connects to a coaxial cable that sends signals to your TV
- 3 IR In** Connects to an optional IR Extender if provided with the DTA by your service provider
- 4 Slide Switch** Can be set to either channel 3 or channel 4
- 5 HDMI** Connect an HDTV HDMI™ (High-Definition Multimedia Interface) cable from the HDTV to the HDMI port. HDMI supports both digital audio and video
- 6 DC Power Input** Connects to the external power supply for the DTA

**Note:** This illustration may vary from the actual product.

**! POWER SUPPLY WARNING: Only the supply that came with your system may be safely used to power the DTA.**

## Safety First

Before using this DTA, read the IMPORTANT SAFETY INSTRUCTIONS section of this guide.

## Avoid Screen Burn-In

Images such as letterbox bars or side bars, bright closed-captioning backgrounds, station logos, or any other stationary images may cause the TV screen to age unevenly and cause damage to your TV. Refer to the user guide that came with your TV for more information about screen burn-in.

## Installing the DTA

**! WARNING: Electric shock hazard! Unplug all electronic devices before connecting or disconnecting any device cables to the DTA.**

### TVs with an HDMI Connector

1. Connect the DTA to the coaxial cable coming from the wall.
2. Connect an HDMI cable from the DTA to your TV.

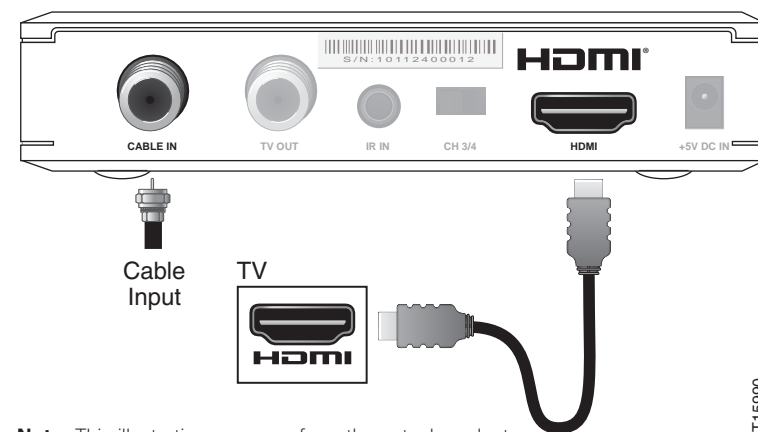

**Note:** This illustration may vary from the actual product.

### Other TVs

1. Connect the DTA to the coaxial cable coming from the wall.
2. Connect a coaxial cable from the DTA to your TV.
3. Slide the switch to channel 3 or channel 4 based on the channel your service provider uses.

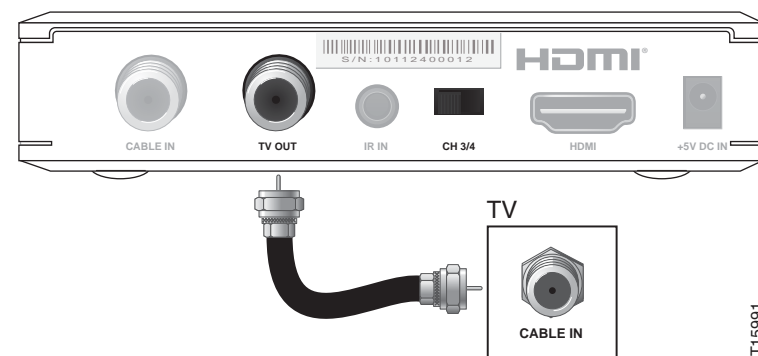

### All TVs

After connecting your TV to the DTA:

1. Plug the power cord from the external power supply into the DTA.
2. If you received an IR Extender from your service provider, read and follow the installation instructions in *Connecting an Optional IR Extender*.
3. Plug the DTA's external power supply and the TV into an AC power source.
4. The DTA will power on once plugged in (indicated by a green light on its front panel). Follow the on-screen steps or instructions provided by your Service Provider for initial activation.

## Performance Tips

If the DTA does not perform as expected, the following tips may help.

### No picture

- Verify that the power to your TV is turned on.
- If the DTA is plugged into a wall switch, verify the switch is in the ON position. (Avoid plugging into an outlet that is controlled by a wall switch.)
- Verify that all cables are properly connected.
- The current channel may not be available in your service package. Try selecting another channel to see if a picture appears.

### No color

- Verify the current TV program is broadcast in color.
- Adjust the TV color controls.

### No sound

- Verify the volume is turned up.
- Verify the mute function is not on.

## Mounting the DTA to a TV with Optional Hook-and-Loop Squares

1. Remove one of the two optional hook-and-loop mounting squares from the carton in which your DTA unit was shipped.

**Note:** Mounting the DTA to your television may be easier if the loop tape remains attached to the hook fastener.

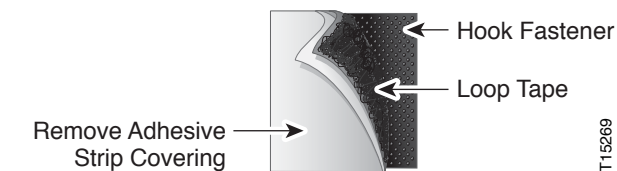
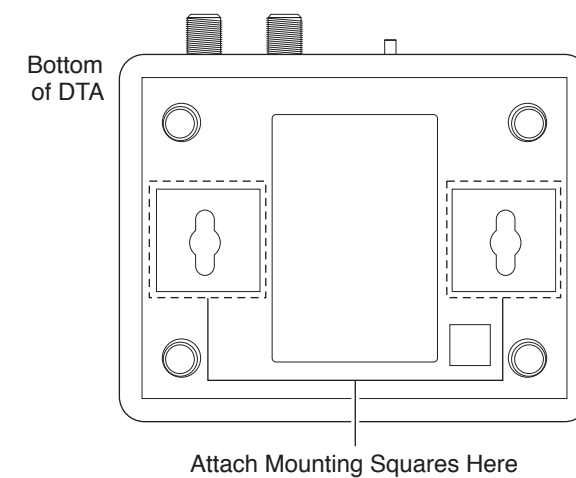

2. Peel the paper backing from the loop tape on the mounting square you selected.
3. Press and hold the mounting square against the bottom of the DTA until the square forms a secure bond.
4. Repeat steps 2 - 3 for the other mounting square.
5. Peel the paper backing from the hook fastener on each of the mounting squares.
6. Press and hold the mounting squares to the top or back of your television until the squares form a secure bond.

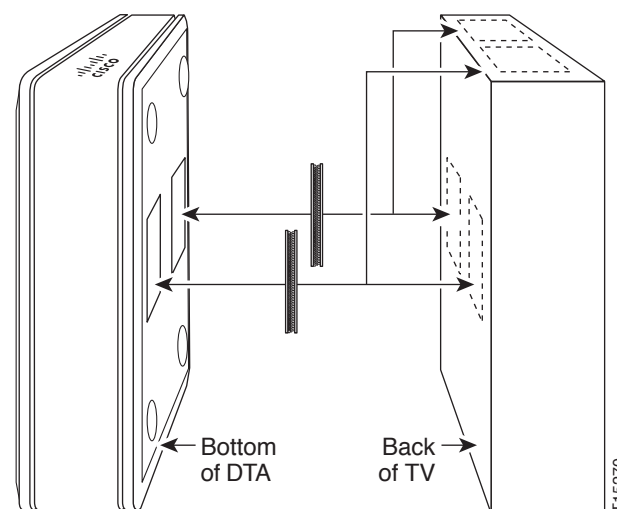

## Connecting an Optional IR Extender

The IR Extender, if packaged with your DTA, allows you to install your DTA in an unobtrusive location, such as a cabinet, and control your DTA with a remote control.

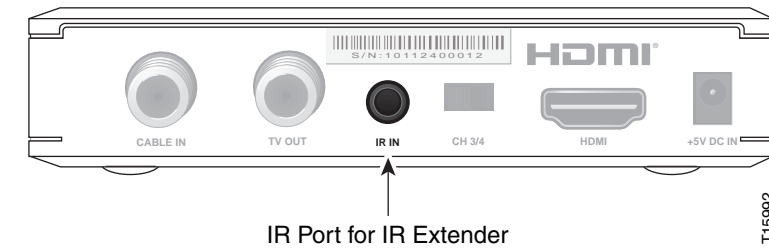

1. Plug the connector into the IR port on the back of the DTA.
2. Peel the paper backing from the adhesive pad on the bottom of the receiver. Then, mount the IR Extender receiver in an inconspicuous place, but make certain that nothing blocks the sensor on the front of the receiver. You must be able to point the remote control at this sensor.

To control the DTA, press the keys on the remote control while aiming the remote control at the sensor on the receiver.

**Note:** If you encounter problems, make sure that all connections are secure and that nothing blocks the path between the receiver and your remote control. For further assistance, contact your service provider.



**Important:** Do not block the sensor on the front of the receiver, or you cannot control the DTA with your remote control.

Place the sensor away from compact fluorescent light, plasma TV displays, or LCD HDTVs. The sensor signal may be blocked when placed too close to these types of devices, and the remote control will no longer function properly.

